

BL-589
www.BoardFree.kr

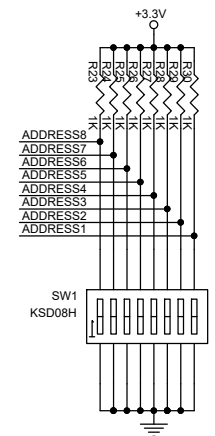
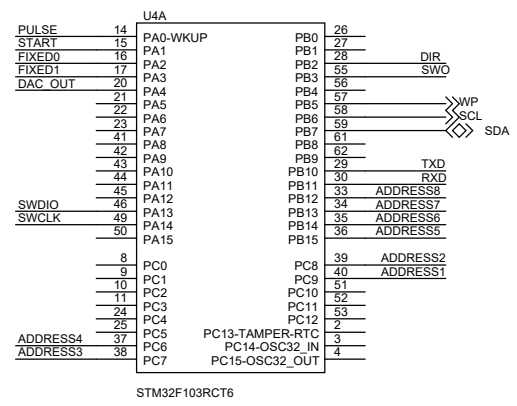
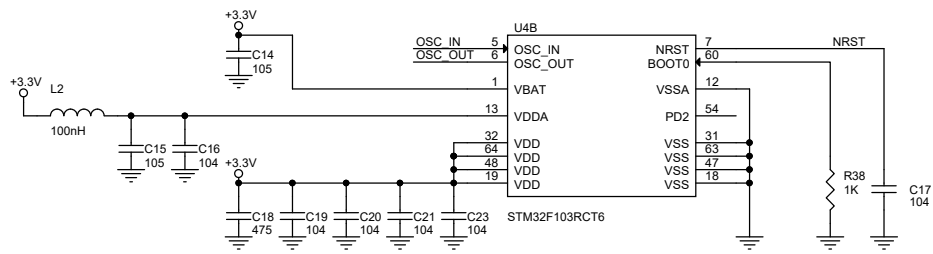
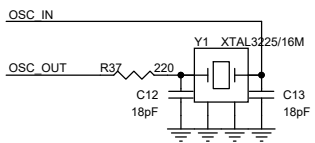
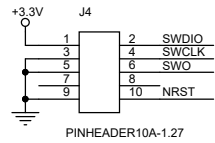
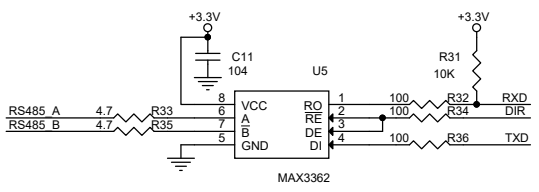
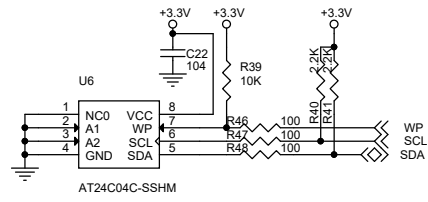

TEL: 02-1544-7192
 FAX: 0303-0554-3035
 E-MAIL: pcb@boardlab.net

Date: Thursday, February 29, 2024

Model: BL-589(CPG)	Rev: 1.0
Size: A3	Sheet 1 of 1
Designer: KIM YONG PHIL	

Notes: <Note>